

USER MANUAL

DentalDeal



ELECTROSURGERY UNIT

ES-20

Product Name High-frequency Electrosurgery Unit

Product Model: ES-20

Product Structure: This device is composed of one electrosurgery main unit, one footswitch, one neutral electrode, a box of 7 pcs electrodes (C30C C40C EC10N EX22R C30S C40S EC25B), one set of electrode holder with cord.

The product has two working modes: cutting mode and mixed mode.

The device output frequency is 1.2 MHz and the rated power is 30W under the rated load of 600Ω.

Scope of Application: This medical device is used for the incision and coagulation of soft tissue and is used in medical institutions.

Production Date: See device external labels

Use Period: 5 years

Instruction for Use: See the following

Manual Version: 202204

CONTENTS

1. INTRODUCTION	1
1.1 Contents of the document	1
1.2 Retention time	1
2. OPERATING INSTRUCTIONS	1
3. WARNINGS	1
3.1 User population	1
3.2 Specific user training	2
3.3 Patient population	2
3.4 Restriction of the patient population	2
3.5 Parts of the body or types of tissues treated	2
3.6 Essential performance/Basic operating safety/Normal operating conditions	2
3.7 Lifetime/Breakage/Broken electrodes	3
3.8 Warnings specific to electrosurgical devices	3
4. INTERACTIONS/CONTRAINDICATION/PROHIBITIONS	4
4.1 Use	4
4.2 Electromagnetic compatibility	4
4.3 Interference with other medical devices	4
4.4 Use of accessories other than those supplied by original manufacturer	4
4.5 Use	4
4.6 Moving the device	4
4.7 Fitting/Removal of control knobs	4
5. DESCRIPTION OF THE DEVICE	5
5.1 Composition	5
5.2 Physical description	5
5.3 Technical description	5
5.4 Technical specifications	6
5.5 Operating principle	7
5.6 Significant performance characteristics	7
6. UNPACKING/INSTALLATION/CONNECTING THE DEVICE	8
6.1 Unpacking the device	8
6.2 Installation	8
6.3 Making the electrical connections	8
7. BEFORE USING THE DEVICE FOR THE FIRST TIME	8
8. USING THE DEVICE	9
8.1 Switching ON the device	9
8.2 Fitting the bracelet (neutral electrode)	9
8.3 Installing the electrode holder	9
8.4 Fitting the electrode	9
8.5 Using the device	9
9. SWITCHING OFF THE DEVICE	10
10. CLEANING/PRE-DISINFECTING THE DEVICE	10
11. CLEANING/DISINFECTING/STERILIZING ACCESSORIES	10
12. MONITORING/GENERAL MAINTENANCE	12
12.1 Monitoring	12
12.2 General maintenance	12
13. TROUBLESHOOTING BY THE USER	13
14. REPAIRS / MODIFICATIONS	14
15. ELECTROMAGNETIC COMPATIBILITY	14
16. DISPOSAL AND RECYCLING	14
17. MANUFACTURER'S LIABILITY	14
18. REGULATIONS / STANDARDS	14
19. SYMBOLS USED / DRAWINGS	15

1.CONTENTS

The device you are about to install and use in your surgery is a medical instrument for professional use only. It's an ideal tool to provide treatment as part of your healthcare activity.

Please read these instructions carefully for you and your patients' safety, improved comfort in your daily practice and to get the most out of your device's technology.

If you have received this device by mistake, please contact the sender to arrange for its return.

1.1 Contents of the document

This document is a user manual specific to your device: Electrosurgery Unit ES-20

It contains the following information concerning, in particular:

- Operation instructions
- Patients, users and environment safety
- Installing your device in optimal conditions
- Descriptions of the device
- Useful instructions before using the device for the first time
- Using the device
- Switch off the device
- Cleaning / disinfecting the device
- Monitoring and general maintenance
- Troubleshooting by the user

1.2 Retention time

Users are asked to keep the documentation to hand so that it can be consulted whenever necessary.

All paper or electronic documentation relating to your device must be kept for the entire service life.

When loaning out or selling the device, the documentation must be supplied with it.

2.OPERATING INSTRUCTIONS

This medical device is only used for the incision and coagulation of soft tissue.

It is used in conjunction with a bracelet (neutral electrode) and an electrode holder which can be fitted with a wide range of monopolar incision or coagulation electrodes using high-frequency electrical energy.

3.WARNINGS

Note: The following notice is only applicable for the United States of America.

The Federal Law of the United States restricts the use of this device on its territory to qualified, fit and certified dental healthcare professionals or to its use under their control.

Warnings applicable to all countries where the device is sold

Note: The following information is from the normalization requirements which the manufacturers of medical devices must comply with (in the sense of the IEC standard).

To reduce the risks of accidents, the precautions detailed below must be respected.

3.1 User population

This medical device must be only used by the qualified dental health practitioners, fit and certified to perform their professional duties.

Users must master and respect the rules of dental practice consistent with the knowledge acquired in the field and the medial hygiene principles including cleaning, disinfection and sterilization of medical devices.

This medical device can be used irrespectively of specific (adult) user details such as weight, age, height, gender and nationality.

The user must wear medical gloves.

The user is not the patient.

Users shall not have:

- Any vision problems that cannot be corrected by eyeglasses or lenses.
- A disability of the upper limbs (correct grip of an electrode holder) or lower limbs (operation of a control footswitch).
- Hearing problems (use of audible signals, depending on the equipment).
- Memorization or concentration problems (settings, treatment sequences or protocols, etc).

3.2 Specific user training

No specific training other than initial professional training is required to use this medical device.

The practitioner is responsible for the clinical acts and for the possible dangers arising from a lack of competency and/or training.

3.3 Patient population

This medical device is designed to be used with the following patient population:

- Children,
- Adolescents,
- Adult,
- Senior citizens.

This medical device can be used irrespectively of the patient's details such as weight, age, height, gender and nationality.

3.4 Restriction of the patient population

This medical device must not be used on the following patient population:

Nursing infants.

Pregnant or nursing women (restrictions due to the possible use of drug solutions such as anesthetics, etc.)

Patients with medical complications.

Allergic patients.

Patients with a clinical site not suitable for the treatment.

Patients with wrist lesions.

The patient must be calm, relaxed, still and ideally lying on a dental chair.

The user is the sole person to be able to decide whether or not to administer the treatment to his patients.

3.5 Parts of the body or types of tissues treated

Treatment must be only carried out on the patient's oral environment.

3.6 Essential performance / Basic operating safety / Normal operating conditions

Essential Performance

In the sense of the applicable safety standard for electromedical device, the manufacturer has determined that the device does not manage the essential performance.

Basic Operating Safety in Normal Use

The active part is in the practitioner's hand throughout the medical act. As a high skilled medical expert, the practitioner can immediately detect any problems at the treatment area and react accordingly.

The force applied on the electrode holder equipped with its electrode must be controlled by the practitioner according to good dental practices. The basic safety is created by the practitioner.

It is recommended to have a backup device or an alternative means of completing the medical act in the event of an equipment failure.

Normal Operating Conditions

The normal operating conditions are:

- Storage,
- Installation,
- Use,
- Cleaning / pre-disinfection / sterilization,
- Maintenance,
- Disposal.

3.7 Lifetime/Breakage/Broken electrodes

Because it is impossible to determine the maximum number of times the electrode can be used (may depend on many parameters such as operating time, tissues encountered, force exerted, wear, etc.), we recommend you to renew the routinely used electrodes at least each six months.

Breakage/Broken electrodes

An electrode is a medical device to which a certain mechanical force is applied to carry out dental treatment. The electrodes have been developed to be used safely in combination with the electrode holder.

The practitioner may however observe a breakage or rupture phenomenon (according to the rate of use, power exerted, equipment dropped, etc.)

To reduce the risks (however small), we recommend you to use of a suction device (saliva suction canula) and to encourage the patient to breath through his/her nose.

3.8 Warnings specific to electrosurgical devices

Note: The following information is from the normalization requirements which the manufacturer of medical devices for high-frequency surgery are subject to (in the sense of the IEC60601-2-2 standard).

- The whole surface of the bracelet (neutral electrode) must be connected in a reliable manner to the patient's right wrist. The bracelet must be adjusted to remain in direct contact with the patient's skin. The patient must not have skin lesions. Here is no audible alarm if the neutral plate is not correctly places on the patient and/or if the neutral plate cable is disconnected, because the neutral plate haven't monitor.
- The patient should never come in contact with earthed or grounded metal parts, or parts with a high capacitance (e.g. operating table, supports, etc.).
- Skin-to-skin contact (e.g. between the patient's arms and body) must be avoided, for example by placing a dry gauze between them.
- Contact between the patient's skin and that of the practitioners should be avoided.
- If the device is used simultaneously with physiological monitoring devices on the same patient, the monitoring electrodes should be placed as far away as possible from the surgical electrodes.
- Needle-type monitoring electrodes are not recommended. In all cases, monitoring systems with high-frequency current limiting are recommended.
- Surgical electrode cords must be positioned so that all contact with the patient or with other conductors is avoided.
- Active electrodes that are temporarily not being used must be kept well away from the patient.
- During surgical procedures in which the high-frequency current could flow through relatively thin parts of the body, the use of bipolar techniques may be desirable to avoid the accidental damage to tissue.
- The selected output power must be the lowest possible for the required purpose.
- A low output power or malfunction of a high-frequency electrosurgical device at the normal operating settings may be due to an incorrectly fitted conductive bracelet (neutral electrode) or a bad contact in its connections. In this case, check that the neutral electrode and its connections are correctly fitted before selecting a higher power output.
- All use of flammable anesthetics or oxidizing gases such as nitrous oxide (N₂O) and oxygen during the surgical operation must be avoided, unless these agents are evacuated by suction.
- Non-flammable agents must be used for cleaning and disinfection, where possible.
- The flammable products used for cleaning and disinfection or as adhesive solvents must be allowed to evaporate before beginning high-frequency surgery.
- There is a risk of buildup of flammable solutions under the patient or in the depressions or cavities of his/her body.
- Some materials like cotton wool or gauze may, when saturated with oxygen, be ignited by the sparks produced during the normal use of high-frequency electrosurgical devices.
- The interference produced by a high-frequency electrosurgical device may disrupt the operation of other electronic equipment.
- The operator must regularly check the accessories.
- In particular, the electrode cords and accessories must be checked.
- The failure of a high-frequency electrosurgical device may result in an accidental increase in the output power.
- The device must be used in combination with a surgical suction system to reduce the propagation of smoke.
- In some cases, electric arcs between the electrode and the clinical site may induce neuromuscular stimulation. This may result in injuries caused by involuntary and uncontrolled movements.

4.INTERACTIONS/CONTRAINDICATION/PROHIBITIONS

This paragraph is designed to give you all the information concerning the interactions,contraindications and prohibitions known at the time of writing this document.

4.1 Use

The device must not be used in the presence of unruly, emotional or excessively nervous patients.

It must not be used in the following cases:

Incomplete anesthesia

Delicate surgery (mucoperiosteal surgery,grafts,etc.)

Very fragile tissue

Ignorance of the theory of electrosurgery

Lack of practice on anatomical parts

Insufficient knowledge of the patient or his general condition

Presence of metallic surgical equipment implanted on the patient (especially on the high-frequency current conduction path)

4.2 Electromagnetic compatibility

The device is compliant with the current electromagnetic compatibility standards, however the user must ensure that any electromagnetic interference does not create an additional risk (presence of radiofrequency emitters,electronic equipment,etc.).

4.3 Interference with other medical devices

The device must not be used if the patient and/or operator have a pacemaker or any other active implant (cochlear implant,etc.).

The device is not designed to withstand electric defibrillator discharges.

4.4 Use of accessories other than those supplied by original manufacturer

The device has been designed and developed with its accessories to guarantee you a maximum safety and performance. The use of accessories from other sources may represent a risk for you,your patient and your device. Do not attempt to connect accessories not supplied by the original manufacturer to the device's connector(s) or to the electrode holder.

4.5 Use

- Do not cover the device and/or obstruct the ventilation holes.
- Do not immerse and do not use out of doors.
- Do not place the device near a heat source or in direct sunlight.
- Do not expose the device to water mist or spray.
- The device is not designed to operate near an ionizing radiation source.
- A cold/hot thermal contrast may create condensation inside the device which can be dangerous. If the device is to be transported from a cool location to a warm location, do not use it immediately, but only after it has reached the room's ambient temperature.
- The device can not be stored or used outside the specified temperature and atmospheric pressure ranges.
- Do not touch the accessible electrical connections.

4.6 Moving the device

Do not move the device while in use.

After use, the device is not designed to be moved.

4.7Fitting/Removal of control knobs

The control knobs are not designed to be removed or dismantled.

5. DESCRIPTION OF THE DEVICE

5.1 Composition

The equipment configuration consists of six main components:

- One main unit (Fig.1, item 1).
- One control footswitch (Fig.1, item 9).
- One electrode holder with its cord (Fig.1, item 6).
- One mains lead with ground conductor (Fig.1, item 10).
- Bracelet (neutral electrode) with its cord (Fig.1, item 8).
- One box of electrodes.

5.2 Physical description

The main unit has the following items on the top:

- Indicator lamps (Fig.1, item 2).
- Control knobs (Fig.1, item 4/5).

On front of main unit: connector for the electrode holder cord (Fig.1, item 7).

On right side of main unit: electrode holder rest (Fig, item 11).

The following items are on the rear of the main unit:

- 1 connector for the bracelet (neutral electrode) (Fig.1, item 13).
- 1 connector for footswitch (Fig.1, item 14).
- 1 ON/OFF switch (Fig.1, item 12).
- 1 fuse housing (Fig.1, item 15).
- 1 power supply input connector socket (Fig.1, item 16).

5.3 Technical description

a.Indicator lamps

“Active” indicator lamp  (Fig.1, item 2).

This green indicator remains lit as long as the footswitch is pressed and indicates the presence of the high-frequency current. Note that a buzzer sounds (audible signal meeting current standards) when the footswitch is being pressed. The volume is not adjustable.

ON indicator lamp  (Fig.1, item 3).

This indicator is orange and it lights when the device's ON/OFF switch (Fig.1, item 12) is in “I” position (ON).

b.Control knobs

the device is controlled by adjusting the power and coagulation control knobs.

Incision power control knob  (Fig.1, item 4).

Adjusts the incision power from the minimum value to the maximum value.

At maximum power (setting 10), the power delivered is 30W approx.; however, it depends on the operating conditions and the patient's histological variables.

Coagulation control knob  (Fig.1, item 5).

- Value 1: Minimum coagulation.
- Value 2: Maximum coagulation.

The coagulation control knob can not be adjusted without adjustment of the incision control knob.

c.Rear of main unit

- The device's bracelet connector (neutral electrode) (Fig.1, item 13) connects the device to the bracelet cord.
- The footswitch connector (Fig.1, item 14) connects the device to the control footswitch.
- The ON/OFF switch (Fig.1, item 12) switches the device ON or OFF.
- The fuse housing (Fig.1, item 15) contains the protection fuses.
- The power supply input connector socket (Fig.1, item 16) with its ground pin connects the device to the mains electricity + supply via a disconnectable mains lead.

d.Right side of main unit

- The device is equipped with an electrode holder rest which can be removed for sterilization.

e. Front of the main unit

- The connector (Fig.1, item 7) is designed to receive the electrode holder cord.

f. Control footswitch

Pressing the control footswitch activates the device’s high-frequency output. For greater safety, the footswitch can be fixed to the device by two attachment screws present on the footswitch lead connector.

g. Electrodes (Fig.5)

- The C30C/C30S are only for incision.
- The C40C/C40S are only for coagulation incision.
- The EC10N/EC25B are only for fulguration and coagulation.
- The EX22R is only for excision.

5.4 Technical specifications

Identification	
Name of device	High frequency electrosurgery unit
Name of device	ES-20
Generator electrical input characteristics	
Supply voltage	115VAC / 230VAC
Supply frequency	50 Hz / 60Hz
Power consumption	170 VA to 230 VA
Generator output electrical characteristics	
Power output	30W
Characteristic impedance	600Ω
Output impedance range	100Ω to 2000Ω
Output voltage	650V PP - P = 10, W=1
Output frequency	1.2MHz ± 0.2MHz
Protection	
Leakage current type	BF
Electrical class	I
High-frequency output type	Floating (isolated from ground (earth) at high frequency).
Operating mode	
Intermittent operation	5 x (10s ON / 30s OFF) +10 mins stand-by
Safety devices	
Fuses (power supply input connector socket) -115VAC	5mm x 20mm / 2AT
Fuses (power supply input connector socket) -230VAC	5mm x 20mm / 1.25AT
Internal fuse not accessible to the user	F1: 5mm x 20mm - 500mAT / 250VAC
Adjustments	
Incision settings	1 to 10 (relative units)
Coagulation settings	1 to 10 (relative units)

Main unit	
Width (in cm)	23cm
Height (in cm)	11cm
Depth (in cm)	26cm
Weight (in kg)	1.5kg
Cord lengths	
Electrode holder (in mm)	>2000
Bracelet (in mm)	2000
Protection indices	
Main unit	IPX0
Control footswitch	IPX1
Environment characteristics	
Operating temperature	+10°C to +30°C
Storage temperature	-20°C to +70°C
Operating relative humidity	30% to 75%
Storage relative humidity	10% to 100% including condensation
Atmospheric pressure	80KPa to 106KPa
Altitude	≤2000 meters
Environment restrictions	
Operating premises	Usable in all medical premises. The device must not be used in operation theaters.
Use in gas atmospheres	The device is not designed to be used in gas atmospheres type AP or APG or in the presence of anesthetic gas.
Applied parts	
Part in direct contact with the patient	Electrodes
Part in indirect contact with the patient	Electrode holder

5.5 Technical specifications

The medical device converts the low voltage electrical energy into high-frequency electrical energy which flows through the patient’s body between the active electrode fixed to the electrode holder and a bracelet (neutral electrode) in contact with the patient.

The high-frequency electrical energy density at the end of the active electrode produces the desired effect, incision or coagulation.

5.6 Significant performance characteristics

- High-frequency electrical energy frequency.
- Electrical power.
- Characteristics impedance
- Surface of electrodes

6. UNPACKING/INSTALLATION/CONNECTING THE DEVICE

This chapter contains the information necessary to allow you to install and start using your device in the best possible conditions.

6.1 Unpacking the device

When you receive the device, check that it has not been damaged during shipping. If you have received this device by mistake, please contact the supplier to arrange for its return.

6.2 Installation

Installing the device

- Do not install your device on or near another device.
- Place the main unit in a location ideally chosen for your activity.
- The device must be placed on a fixed, horizontal surface or a surface with slope not exceeding 5 degrees.
- Secure your device using the supplied attachment means so that it can not be removed without the use of a tool.
- Adjust the positioning of your device for your viewing angle and the features of your working area (e.g.: lighting, distance between the user and the device, etc.).
- Ensure that you have rapid access to your device.

Installing the different cords

- Do not place the device's cords in a cable cover, cable guide.
- Ensure that cords do not hamper the movements and/or the free circulation of persons.
- Never wind the cords around the device.
- Ensure that it is not possible to run over or step on the different cords.
- The cord equipped with its electrode holder must be easily accessible.
- Ensure that the electrode holder cord is not stretched tightly when being used.

Installing the footswitch

The footswitch must be positioned near the operator's feet and easily accessible.

6.3 Making the electrical connections

Connecting to the mains electricity supply

Have your device connected to the mains electricity supply by an approved dental installation technician.

Before connecting the device, place the ON/OFF switch in "O" position (OFF) and check that mains voltage is compatible with that marked on the device.

A different voltage would damage the device and could injure the patient and/or the user.

The device's electrical connection must be compliant with the standards in force in your country.

Do not place the mains lead in a cable cover or cable guide.

The device is equipped with a protective ground connection that must be connected to a mains power supply with a protective ground.

All voltage fluctuations in the mains electrical supply or electromagnetic field, which are not compliant with the limits in force, could disrupt the operation of the device.

A power outage when using the device can create an unacceptable risk, the user/installer must therefore ensure that the device is connected to an appropriate power source (uninterruptible power supply, etc.).

Do not connect the device to an electrical extension cable.

7. BEFORE USING THE DEVICE FOR THE FIRST TIME

Before using the device for the first time, it is essential to carry out tests on anatomical parts (pieces of meat – ideally, a piece of beef heart, chicken breast, etc.) to determine how they react to incision and to help adopt the right clinical procedure (electrode movement speed). Do not hesitate to repeat these exercises as many times as necessary.

The accessories used on animal parts must not be reused on human patients!

Before using the device for the first time, it is essential that all the equipment should be maintained and/or sterilized using the procedures defined in chapters 10 and 11.

8. USING THE DEVICE

Important

- Do not connect/disconnect the electrode holder when the device is switched ON and the footswitch is pressed.
- Do not touch the electrode when the footswitch is pressed.
- Before and after use, check the whole device and its accessories to detect any problems.
- If problems are found, do not use the device and replace all defective items.
- Do not check the presence of the high-frequency current by creating electric arcs on metal parts, this will damage the device.

8.1 Switching ON the device

Switch the ON/OFF switch to "I" position (ON) (Fig.1, item 12).

The orange indicator lamp on the front of the unit lights (Fig.1, item 3).

The device is now switch ON and ready to use.

Keep the footswitch well away to prevent accidentally activating it during the following phases.

8.2 Fitting the bracelet (neutral electrode)

- Connect the bracelet cord to the connector on the rear of the unit (Fig.2).
- Attach the bracelet to the patient's RIGHT wrist (it is recommended that the current path between the active electrode and the bracelet should not pass through the heart).
- The bracelet must be adjusted to remain in direct contact with the patient's skin.

The whole surface of the bracelet (neutral electrode) must be connected in a reliable manner to the patient's right wrist (Fig.6).

No extrabuccal metallic items must be placed between the work zone and the bracelet. Remove lips and tongue rings before any treatment.

8.3 Installing the electrode holder

Connect the electrode holder cord to the connector on the device (Fig.1, item 7).

8.4 Fitting the electrode

Only insert the electrode appropriate for the surgical procedure (Fig.3).

Important

- Do not use the electrode if the plastic sheath looks damaged (splits, holes, etc.) or is missing. If damaged or missing, replace the electrode.
- It is essential to push the electrode well in so that no metal part is visible between the electrode holder cap and the electrode's plastic sheath (Fig.3).
- Any visible part would cause the current to flow and result in a painful incision in the wrong part in the patient's mouth.
- Replace the electrode holder if it no longer holds the electrode tightly.

The device can be used with a wide range of electrodes.

Adjust the device for electrode used, as indicated in the settings table in figure 4.

8.5 Using the device

- Adjust the incision and coagulation power using the  and  control knobs.

This adjustment must be made before the surgical procedure otherwise there is a risk of burns or undesirable effects.

- Move the footswitch close to your foot.
- Position the electrode on the clinical site.
- Press the footswitch.
- The incision or coagulation effect is then obtained.
- The green indicator lamp lights and the buzzer sounds. It the indicator goes off as soon as the pressure on the footswitch is released.

9.SWITCHING OFF THE DEVICE

- Keep the footswitch well away to prevent accidentally activating it during the following phases.
- Set the device to minimum power using the ◀ control knob.
- Switch the device’s ON/OFF switch to “O” position (OFF) (Fig.1, item 12).
- Remove the bracelet from the patient.
- Disconnect the bracelet cord from the device.
- Remove the electrode from the electrode holder.
- Disconnect the electrode holder with its cord from the device.

At the end of each working day or before a long absence, the device must be switched OFF.

When not in use, or in storage or before a long absence, disconnect the device from the mains power supply.

Before disconnecting the mains lead, switch the device’s ON/OFF switch to “O” position (OFF) (Fig.1, item 12).

To disconnect the mains lead, grasp the mains lead plug while holding the wall socket.

10.CLEANING/PRE-DISINFECTING THE DEVICE

The device’s ON/OFF switch must be in “O” position (OFF) (Fig.1, item 12) during the cleaning/disinfection procedures.

Avoid using cleaning and disinfection products containing flammable agents.

Otherwise, ensure that the product evaporates and that there are no flammable products remaining on the device and its accessories before the device is used.

Do not use abrasive products to clean the device.

Do not use spray products to clean the device.

The device’s main unit, the electrode holder and cord and the footswitch must be cleaned and disinfected (alcohol, disinfectant products,dental surgery disinfectant wipes) on a daily basis.

11.CLEANING/DISINFECTING/STERILIZING ACCESSORIES

Cleaning the bracelet and its cord

The bracelet and its cord must be cleaned and disinfected with disinfectant wipes before use.

Cleaning the electrodes and the electrode holder

Important

Do not use steel wool or abrasive cleaners.

Avoid solutions containing iodine or with a high chlorin content.

The PH of the detergents/disinfectants must be between 7 and 11.

The cleaning method recommended by the manufacturer for the electrodes and electrode handpiece is manual or automatic.

All devices must be carefully cleaned and then undergo a final sterilization before use.

The sterilization parameters are only valid for correctly cleaned devices.

The electrodes require special attention during cleaning.

During automatic cleaning,the electrodes must be placed on suitable instrument holders or in small baskets to prevent them from being damaged during washing.

It is the user’s responsibility to ensure that all equipment used to recondition devices is correctly installed, validated, maintained and calibrated.

Whenever possible, a washer/disinfector should be used for the electrodes and electrode holder cap.

Cleaning/sterilization cycle limits

Repeated conditioning cycles that include ultrasonic cleaning, manual or automatic washing and sterilization have a minimal effect on the electrodes and electrode holder cap.

End of service life is normally determined by wear and damage due to use.

Important remarks

- Soiled devices should be separated from non-contaminated devices to avoid contamination of personnel or surroundings.
- Cover the devices with a soft lint-free cloth dampened with purified water to prevent blood and/or debris from drying.

Storage and transportation

Soiled devices must be transported separately from non-contaminated devices to avoid contamination.

Preparation for pre-disinfection/cleaning

It is advisable to recondition devices as soon as possible after use.

Before cleaning, unscrew the electrode after use.

1 – pre-disinfection/Cleaning-manual method.

Equipment: soft brush, soft lint-free swab, lint-free cloth, alkaline cleaner, ultrasonic cleaner.

Step time(minimum)	Cleaning instructions
1 min	Rinse the solid device under cold running water. Use a soft brush or a soft and clean lint-free cloth to remove most of the contamination and debris.
10 mins	In a ultrasonic cleaner, immerse the device in a freshly prepared alkaline cleaning solution of pH 11 approx.
1 min	Rinse the device under cold running water.
2 mins	Manually wash the device in a freshly prepared alkaline cleaning solution. Use a soft brush to remove the soiling and debris, paying particular attention to the end of the electrode (metal part and intersection between the metal part and the sheath)
1 min	Thoroughly rinse the device with distilled or purified water.
	Repeat the pre-cleaning procedure until all the visible soil is removed from the device.
	Perform a device a final rinse using distilled or purified water.
	Dry the device with a soft, lint-free cloth or with clean compressed air.

2 – Pre-disinfection/Cleaning-automatic method

Note: the manual pre-disinfection/pre-cleaning method must be performed prior to the automatic cleaning.

Equipment: soft brush, soft lint-free swab, lint-free cloth, ultrasonic cleaner, washer/disinfector, alkaline cleaner.

Step time(minimum)	Cleaning instructions
1 min	Rinse the soiled device under cold running water. Use a soft brush or a soft and clean lint-free cloth to remove most of the soiling and debris.
5 mins	In an ultrasonic cleaner, immerse the device in a freshly prepared alkaline cleaning solution of pH 11 approx.
1 min	Rinse the device under cold running water.
2 mins	Manually wash the device in a freshly prepared alkaline cleaning solution. Use a soft brush to remove the soiling and debris, paying particular attention to the end of the electrode (metal part and intersection between the metal part and the sheath). Repeat the pre-cleaning procedure until no visible soiling remains on the device.
1 min	Thoroughly rinse the device with distilled or purified water.
	Repeat the pre-cleaning procedure until no visible soiling remains on the device.

Cleaning-automatic method

Step	Time	Cleaning instructions
Pre-washing	2 mins	Cold tap water
Washing	10 mins	Warm tap water (40°C); use an alkaline cleaning solution pH 11
Neutralization	2 mins	Warm tap water with neutralizer, if necessary (40°C)
Rinsing	2 mins	Rinse with warm distilled or purified water (40°C)
Drying	40mins	90°

Inspection

- Devices must be examined to check that no soiling remains, that they are not corroded, that their sharpness is not dulled and that they are not discolored or damaged.
- Before conditioning and sterilizing the cleaned devices, check they are clean, undamaged and function properly.
- Damaged devices must be discarded, they must not be lubricated.

Packaging

Use suitable packaging or a reusable rigid sterilization container, the sterile barrier system must be compliant with the ISO 11607. avoid all contact between the devices and other objects which could damage their surface or the sterile barrier system.

Sterilization

Unless otherwise specified, non-sterile products can be resterilized using validated steam sterilization methods (ISO 17665 or national standards).

Recommendations for packed electrodes and electrode holder are as follows:

Type of cycle	Sterilization exposure time	Sterilization exposure temperature	Drying time
Saturated steam force air removal (pre-vacuum)	3 - 18 mins	134°C	Minimum 20 mins

Drying time generally range from 20 to 60 minutes according to the type of packing materials (sterile barrier system, e.g. reusable rigid containers or wraps), steam quality, device materials, total weight, sterilizer performance, and cool-down time differences.

The distributor and manufacturer accept no responsibility for sterilization procedures performance by the customer that are not carried out according to the above recommendations.

Storage

Storage conditions for products labeled “STERILE” are printed on the packing label. Package products should be stored in a clean, dry environment, protected from direct sunlight, pests, humidity and extreme temperature. Use the products in the order in which they are received (“first in, first out” principle), taking into account the expiry date marked on the label.

12.MONITORING/GENERAL MAINTENANCE

12.1 Monitoring

Before and after use, the user must check the whole device and its accessories to detect any problems.

Regular monitoring of the device and its accessories is necessary to detect any insulation problems or damage. Replace where necessary.

It is important to monitor the cleanliness of the main unit’s ventilation holes to avoid overheating.

12.2 General maintenance

The device requires no preventive maintenance plan other than monitoring the accessories and routine maintenance (cleaning/disinfection/sterilization).

The device is a class IIb medical device.

13.TROUBLESHOOTING BY THE USER

In case of problems and before contacting your supplier’s or after-sales service, please consult the following table.

If the problem persists, do not use the device if it seems to be damaged or defective.

In case of problems, isolate the device and make sure that it cannot be used.

Fault	Possible Causes	Corrective Action
Nothing working	Mains lead not properly connected	Check the mains socket outlet Return to supplier
	The ON/OFF switch is set to “O” position (OFF)	Switch the ON/OFF switch to “I” position (ON)
	No electric current	All in an electrician
	Power supply input connector socket fuse(s) not working	Return to supplier
The green indicator lamp light up but the orange indicator and the buzzer don’t work	Footswitch lead not properly connected	Check the footswitch. Plug in firmly.
	Faulty footswitch	Replace the footswitch or contact the supplier.
	Device thermal cut-out activated	Wait for the device to cool down.
The indicator lamps come on and the buzzer is working but there is no high-frequency current	Electrode holder cord not properly connected	Check electrode holder cord and push unit-side connector in properly.
	Bracelet connector not properly connected	Check the bracelet connector
	Other possibilities	Return to supplier
The electrode incises with difficulty or is not incising at all	Intensive use. Thermal cut-out activated	Allow the deice to cool down
	Neutral electrode (bracelet) in the wrong position	Check that the whole surface of the bracelet is in closed contact with the patient skin of right wrist
	Soiled electrode	Switch the device to “O” (OFF) and clean the electrode
	Electrode moving too fast	Reduce the electrode moving speed
	Inappropriate electrode	Replace the appropriate electrode
The electrode sticks to the biological tissue	Power set too low	Increase power up to the incision threshold. There is no need to go beyond this threshold
	Inappropriate electrode	Select the appropriate electrode for the operating procedure.
The electrode cuts but there are sparks	Incision power set too high	Reduce the incision power down to the incision threshold. There is no need to go beyond this threshold

Replacing the main fuses

The device is protected by two fuses located in the power supply input connector socket (Fig.1, item 15).

To change the fuses proceed as follows:

Switch OFF the device (“O” position).

Disconnect the mains lead from the power supply.

Disconnect the mains lead from the power supply input connector socket (Fig.2).

Insert the tip of a flat screwdriver into the slot above the fuse holder to release it.

Remove the blown or defective fuses.

Replace the blown or defective fuses by fuses of the same type and rating.

Replace the fuse holder in its housing by pushing it until you hear a click which indicates it is correctly in place.

Connect the mains lead to the power supply input connector socket (Fig.2).

Connect the mains lead to the mains power supply.

A thermal cutout is activated if the unit is used intensively and/or if the following operating cycle is not respected: 5 x 10s operating cycles / 30s stop then 10 minutes stand-by.

14.REPAIRS / MODIFICATIONS

Contact your device’s supplier rather than just and repairer who could make your device dangerous for you and your patients.

Do not repair or modify the device without prior authorization from manufacturer.

If the device is modified or repaired, specific checks and tests must be carried out to ensure that it can still be used in total safety.

If in doubt, contact the supplier.

15.ELECTROMAGNETIC COMPATIBILITY

Note: All the following information is from the normalization requirements which the manufacturers of electromedical devices must comply with (in the sense of the IEC60601-1-2 standard).

This chapter provides the information necessary to ensure that your device is installed and operates in the best possible conditions in terms of electromagnetic compatibility.

The device's various cords must be kept away from each other.

Some types of mobile telecommunications equipment such as mobile telephones may interfere with the device. The separation distances recommended in the present chapter must be strictly respected.

The device must not be used near or placed on another device. Where this is not possible, a check must be carried out before use to ensure it functions correctly.

The use of accessories other than those specified or sold by original manufacturer as spares may increase the device’s emissions or reduce its immunity.

16.DISPOSAL AND RECYCLING

As electrical and electronic equipment, the device must be disposed of according to a specialized procedure for collection, pick-up and recycling or destruction (in particular on the European market, with reference to Directive no. 2002/96/EC of 27/01/2003).

When your device reaches the end of its life, we consequently recommend that you contact your dental equipment dealer for information on how to proceed.

17.MANUFACTURER’S LIABILITY

The manufacturer shall under no circumstances be liable if:

- the manufacturer’s installation recommendations have not been followed (supply voltage, electromagnetic environment, etc.)
- repairs or other work have been done on the device by persons not authorized by the manufacturer
- the device has been used connected to an electrical system that does not comply with current regulations
- the device has been used in ways other than those specified in this manual
- accessories (electrodes, electrode holder, etc.) other than those supplied by original manufacturer have been used
- the instructions in this document have not been followed.

Note: The manufacturer reserves the right to modify the device and/or all documentation without prior notice.

















18.REGULATIONS / STANDARDS

This medical device is compliant with the basic requirements of European Directive 93/42/EEC.

This equipment has been designed and developed according to the IEC60601-1 electrical safety standard and the IEC60601-2-2 collateral standard in force.

This equipment has been designed and manufactured according to an ISO 13485-certified quality assurance system.

19.SYMBOLS USED / DRAWINGS

1		See the user manual before use
2		Class BF
3		Patient circuit isolated from ground (earth) at high frequency
4		Class II
5		Sterilization at 134°C in a autoclave
6		Do not dispose of in household waste
7		Year and month of manufacture
8		Alternating current
9		Control footswitch
10		Device power OFF
11		Device power ON
12		Bracelet (neutral electrode)
13		Incision power regulation
14		Coagulation power regulation
15		Series number
16		Power indicator
17		Working indicator

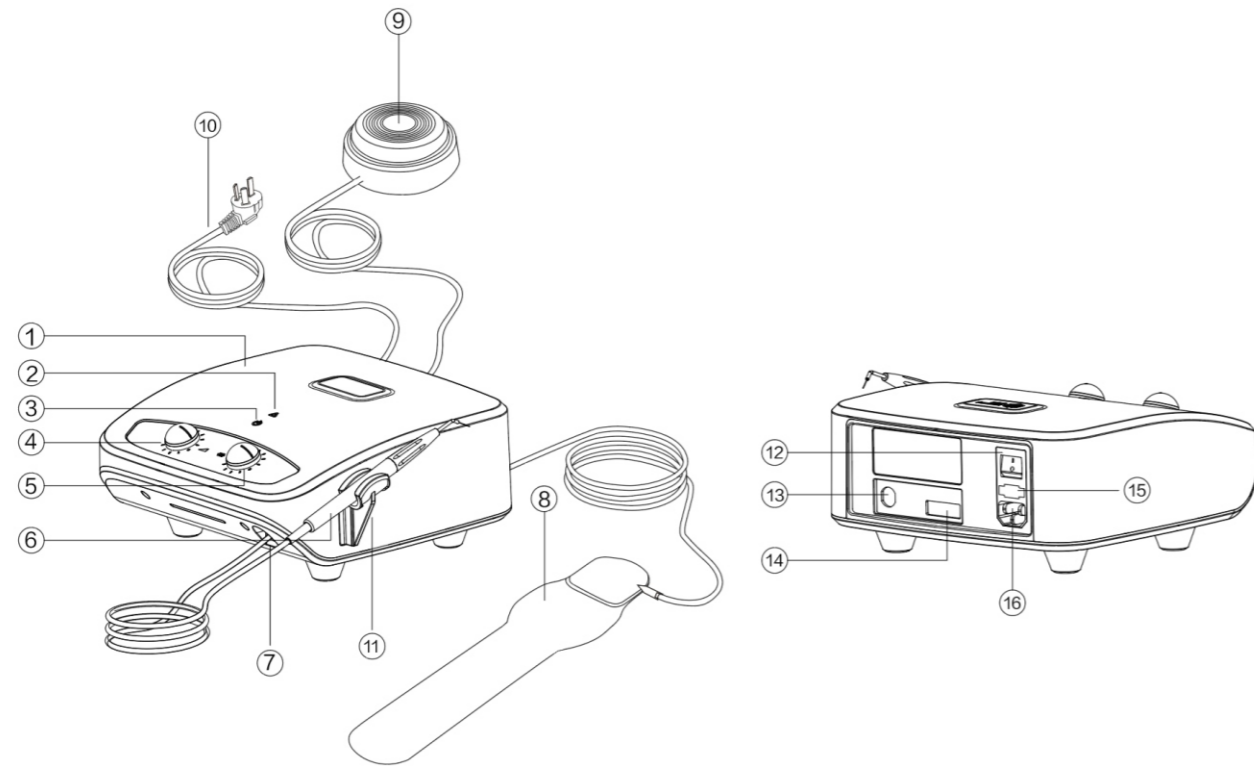

Fig.1

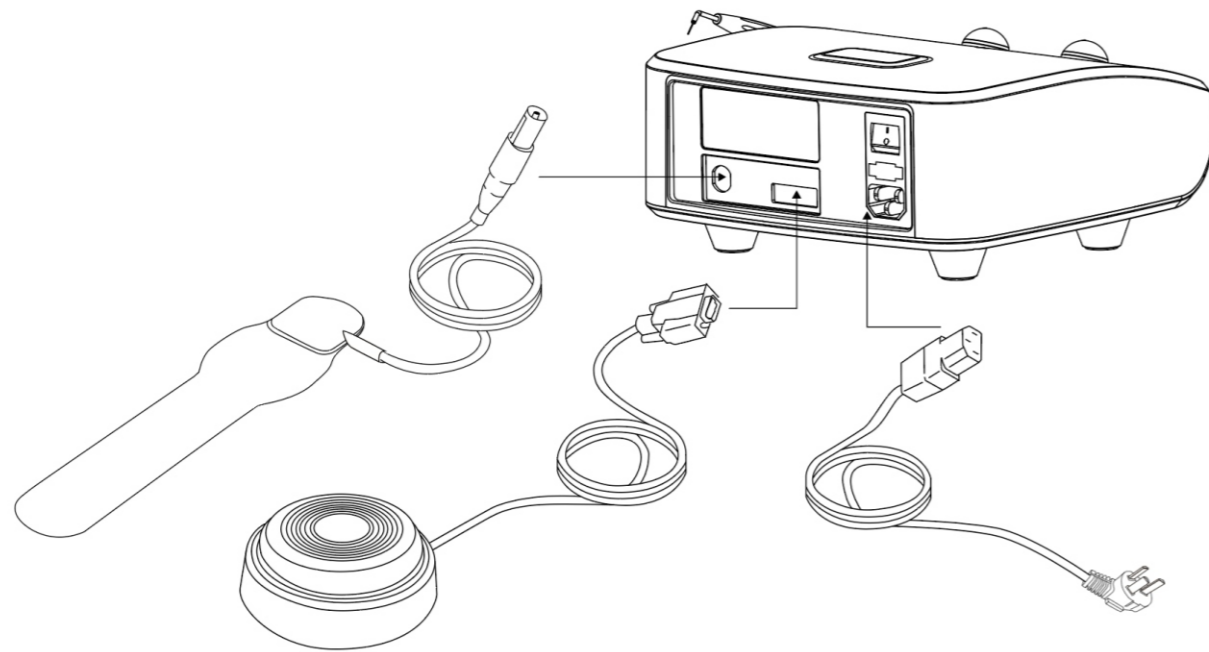

Fig.2

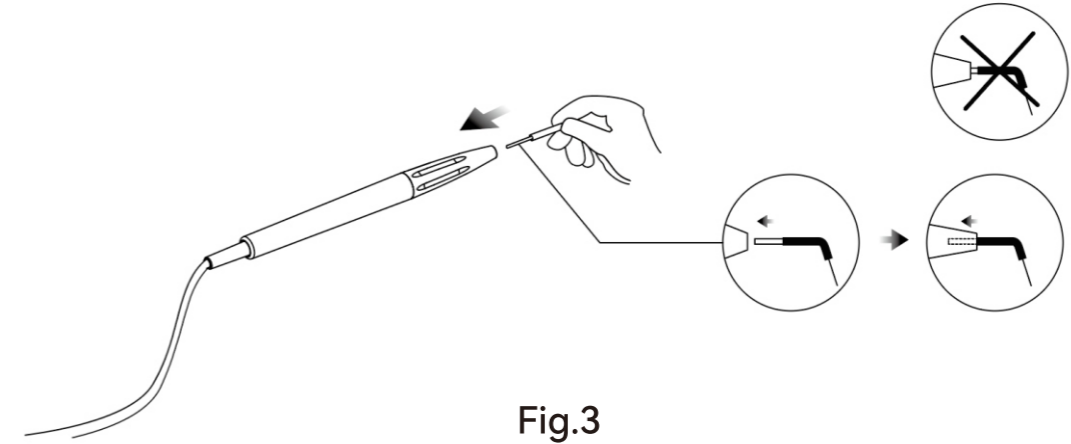

Fig.3

Electrodes		Coupe	Coupe + Coagulation Min & Max					Coagulation	Fulguration
		■ 1	■ 2	■ 4	■ 6	■ 8	■ 10	■ 1	■ 1
C30S	C30C	▲ 3	▲ 3/4	▲ 3/4	▲ 4/5	▲ 5/6	▲ 5/6		
C40S	C40C	▲ 3/4	▲ 3/4	▲ 4	▲ 4	▲ 5/6	▲ 5/6		
EX22R		▲ 4	▲ 4/5	▲ 4/5	▲ 5	▲ 5/6	▲ 6		
EC10N									▲ 5/6
EC25B		▲ 5						▲ 5	▲ 6/7

Fig.4

Electrodes			
Model	Fig.	Model	Fig.
C30C Diameter: 0.30mm		C30S Diameter: 0.30mm	
C40C Diameter: 0.40mm		C40S Diameter: 0.40mm	
EC10N Diameter: 1mm		EC25B Diameter: 2.5mm	
EX22R Diameter: 0.22mm			

Note: the diameter is the size of inox part of electrodes which contact with patient directly.

Fig.5

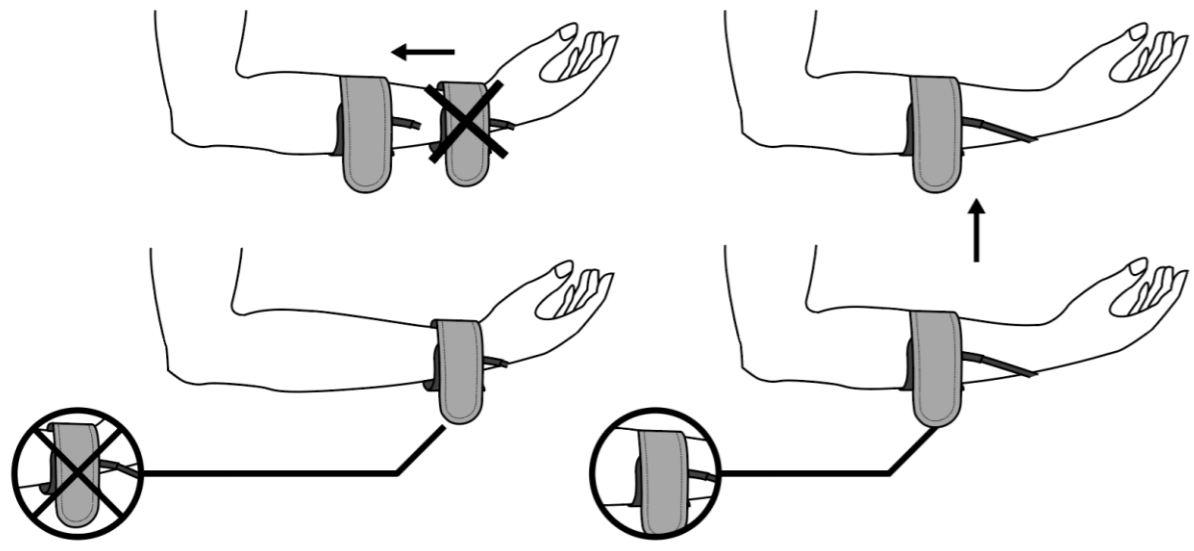

Fig.6

DentalDeal